

INSTALLATION AND SPECIAL CONSIDERATIONS MANUAL



► The Mesa® Retaining Wall Systems can easily accommodate a variety of design considerations.

Table of Contents

Introduction	4
Mesa® Units and Connectors	5
Construction and Quality Control	6
1.1 Construction Responsibilities	6
1.2 Materials and Handling	6
1.3 Wall Construction Preparatory Work	7
1.4 Wall Construction	8
1.5 Geogrid and Connector Placement	9
Mesa Curves and Corners	11
2.1 Concave Curves	11
2.2 Convex Curves	12
2.3 90-Degree Outside Corners	13
2.4 90-Degree Inside Corners	14
Mesa Steps and Stairs	15
3.1 Steps in Front of Wall	15
3.2 Steps in Wall	16
Tiered and Top of Wall Finishes	17
4.1 Tiered Walls	17
4.2 Traffic Barriers	17
4.3 Guide Rails	18
4.4 Handrails and Fence Posts	18
Mesa Wall Details	19
General Terms	24

➤ Endless aesthetic options with
The Connection You Can Count On™



TENSAR® GEOGRIDS

The Mesa® Systems owe their long-term performance and durability to high-strength **Tensar® Uniaxial (UX) Geogrids**. Due to their stiff interlocking capabilities, these geogrids stand the test of time, outperforming other commercially available geosynthetics.

For more information, visit www.tensarcorp.com.

Introduction

THE CONNECTION YOU CAN COUNT ON™

The Mesa® Retaining Wall Systems from Tensar International Corporation (Tensar) offer superior and cost-effective solutions for all of your retaining wall needs. Unlike other segmental retaining wall (SRW) systems, the Mesa Systems incorporate a positive, mechanical connection between the wall face and the Tensar® Geogrid reinforcement. This provides unsurpassed structural integrity that greatly reduces the chance of wall failure, even under the most severe conditions.

Designed as a truly integrated solution, Mesa Walls are also the only SRW system that comes from a single source of supply and demand. Every wall component has been specifically created to work together for optimum efficiency and performance. High strength, low absorption concrete units, corrosive resistant connectors and Tensar Geogrids all work together to create a mechanically stabilized earth (MSE) system that meets or exceeds every industry standard.

ENDLESS DESIGN OPTIONS

No matter which consideration is needed, the Mesa Systems have a solution. Curved walls blend with natural contours, inside and outside corners complement traditional angular looks of existing structures and steps and stairs provide functionality, allowing for limitless wall designs. From structural walls to tiered gardens, the Mesa Systems blend effortlessly with the natural surroundings of any site. Available throughout the United States, Latin America and Canada, the Mesa Systems are produced and sold locally through a large network of authorized distributors.

The following pages of this manual provide a general guideline to assist you in the construction of Mesa Retaining Wall Systems for a wide variety of special considerations. Whether you require stairs, 90-degree corners or convex and concave curves, the Mesa Systems can easily accommodate any project's design consideration.

Mesa® Systems' Components	
Component	Function
Tensar Geogrids	High-density polyethylene (HDPE) structural geogrids internally reinforce fill materials. Inert to chemical degradation, they can be used with different backfills, including recycled concrete.
Mesa Segmental Units	High-strength concrete block with a compressive strength that exceeds the National Concrete Masonry Association (NCMA) standards (>4,000 psi) (27.6 mpa).
Mesa Connectors	Unique locking connectors are designed to mechanically connect the Tensar Geogrids to the Mesa Units. They provide a low-strain, end-bearing connection that is not dependent on friction for structural integrity and allow walls to be built near vertical or with a 5/8 in. (1.6 cm) setback.
Full Engineering and Construction Services	Detailing, design, site assistance and stamped drawings available for each Mesa project upon request.



Mesa® Units and Connectors

To further meet the aesthetic needs of any property, Mesa® Units are offered in a straight or radius face and are locally available in a wide variety of colors and textures. Custom colors may also be produced for higher-profile installations, and the innovative design of the unique Mesa Connector allows units to be installed with a near-vertical face or a 5/8 in. (1.6 cm) setback option – profiles not all SRW systems can provide.

To get in touch with your local authorized Mesa wall distributor, please call **800-TENSAR-1**.

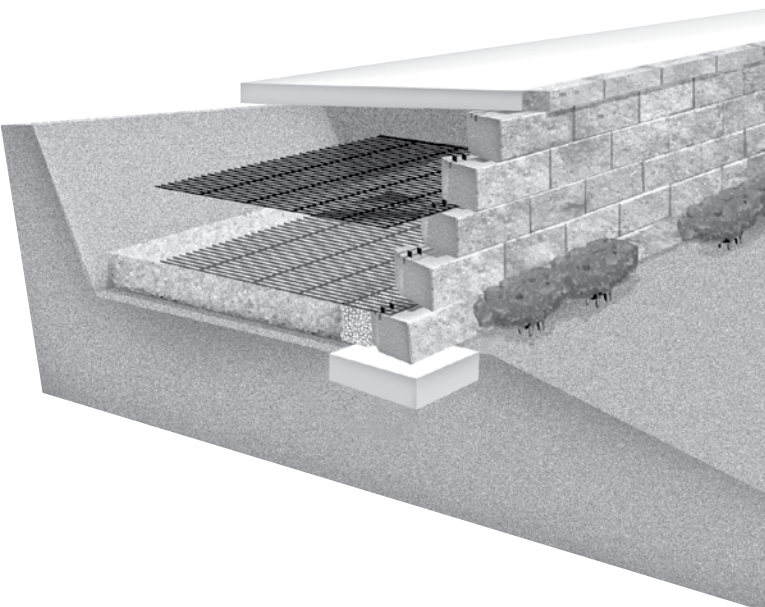

Mesa Standard and DOT Connectors



The Mesa Standard Connectors positively connect Tensar® Geogrid to the Mesa Facing Unit, often eliminating the need for core fill.



The Mesa DOT Connector engages the geogrid across the entire block width.



Standard Units

The most popular Mesa Unit in our full line of products. The Standard Unit can be used for most retaining wall needs.

8" h x 18" w x 11" d nom./75 lbs
(20 cm x 46 cm x 28 cm/34 kg)



Ashford™ Units

Create randomly patterned walls using the Mesa® Ashford™ System. Units are available in three sizes for a variety of facing options (available only with a straight split).

Standard Unit: 8" h x 18" w x 11" d nom./75 lbs
(20 cm x 46 cm x 28 cm/34 kg)

Medium Unit: 8" h x 12" w x 11" d nom./60 lbs
(20 cm x 30 cm x 28 cm/27 kg)

Tall Unit: 16" h x 6" w x 11" d nom./60 lbs
(40 cm x 15 cm x 28 cm/27 kg)



Corner Units

Used to create walls with clean and precise 90° corners.

8" h x 18" w x 9" d nom./60 lbs
(20 cm x 46 cm x 23 cm/27 kg)

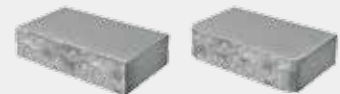

Cap Unit

Used at the top of the wall for a finished look.

4" h x 18" w x 12" d nom./40 lbs
(10 cm x 46 cm x 28 cm/18 kg)

NOTE: Actual dimensions and weights may vary slightly depending on location.

FIGURE 1: Prepare for wall construction by clearing the site and cutting and color-coding the Tensor® Geogrid.



Construction and Quality Control

1.1 CONSTRUCTION RESPONSIBILITIES

This installation section of the manual provides general guidelines for construction and quality control of the installation. This section should be provided to the owner's engineer, the construction quality assurance inspector and the contractor. Specific construction details and procedures depend on individual site conditions and other considerations, which are the responsibility of the owner and engineer.

NOTE: All installation instructions apply to the Mesa® Standard Unit except where otherwise stated.

The contractor must provide construction in accordance with the contract documents, plans and specifications. The contractor is also responsible for the verification of line, grade and other physical features as well as surface water drainage control.

1.2 MATERIALS AND HANDLING

Materials Supplied

- ▶ Mesa Units and Connectors
- ▶ Mesa Cap Units (where required)
- ▶ Tensor® Uniaxial (UX) and/or Biaxial (BX) Geogrids
- ▶ Drainage composite and piping (where required)
- ▶ Geotextile filter materials (where required)

Handling Wall Materials

- ▶ The concrete facing units are delivered on pallets and off-loaded by the contractor. Transporting equipment must have firm ground and a stable, level area to off-load. A forklift is normally used to handle pallets. If pallets are the property of the block manufacturer, they must be stored by the contractor for pick up. The contractor must provide protection from staining or discoloration of the units by using wood dunnage and polyethylene sheet film, or similar.
- ▶ The Mesa Connectors are shipped in cartons and should be stored in a secure and dry location.
- ▶ Tensor Geogrids are shipped in roll form; the contractor is responsible for off-loading.
- ▶ Geogrid rolls should be stored in a secure area. Each roll will be labeled by type, lot number and roll number.

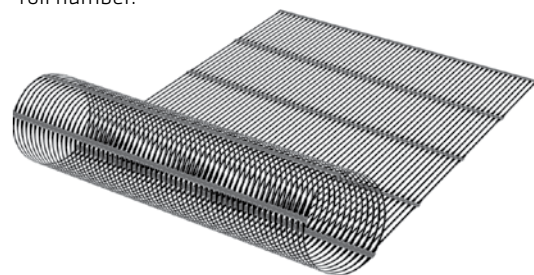

- ▶ Standard Tensor UX Geogrid roll sizes are 4.36 ft wide x 200 or 250 ft long (1.33 m x 61 m or 76 m). Rolls weigh between 87 and 170 lbs (40 and 77 kg) depending on type. Before labels have been removed, rolls should be color-coded with spray paint to help identify geogrid type (Figure 1).

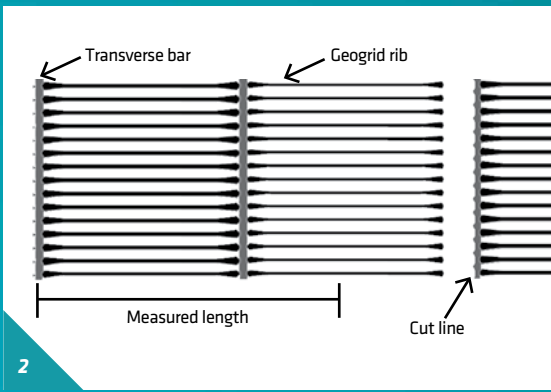

FIGURE 2: Cut Tensor Geogrid at nearest transverse bar beyond the measured length.

FIGURE 3: The base course of Mesa® Units.

- ▶ It is the contractor's responsibility to verify the quantities shipped and condition of the materials. The contractor will inventory materials supplied to assure sufficient quantities have been delivered.
- ▶ The contractor will be allowed a limited amount of time to off-load materials.
- ▶ If certifications are required, the contractor must provide a written request prior to shipment of the material. The contractor will ensure that all information, including product type, roll/lot number, etc. is furnished to the engineer.

Contractor Supplied Materials

- ▶ Dead blow hammer
- ▶ 2- or 4-ft (.61 or 1.22 m) levels
- ▶ Utility saw and/or grinder
- ▶ Masonry string and chalk line
- ▶ All cast-in-place concrete and structural components
- ▶ Stone filter medium
- ▶ Reinforced or select fill
- ▶ Pitchfork, stakes and/or rods used to remove slack from geogrid
- ▶ All labor, equipment and supervision necessary to perform the total Mesa® Wall construction

1.3 WALL CONSTRUCTION PREPARATORY WORK

- ▶ Verify approval of Mesa Units, Tensor® Geogrids and the specified reinforced fill.
- ▶ Review drawings to plan geogrid layout. Review drawings and site plans to consider surface water drainage control both during and after construction.

- ▶ Prepare subgrade by excavating vertically to plan elevation and horizontally to design geogrid lengths. If a rock face is shown, it is the responsibility of the Engineer to determine the competency of the rock at the limits of excavation shown on those plans.

NOTE: Any deviation in the location of the rock face with respect to the face of the retaining wall may require an adjustment to the Tensor Geogrid design and the Engineer of Record must be notified by the contractor prior to proceeding with the wall construction.

- ▶ The subgrade shall be approved before proceeding with wall construction. Any foundation soils found unsuitable by the engineer shall be treated in a manner approved by the engineer.
- ▶ To speed up construction on larger projects, we suggest cutting the Tensor Geogrids in advance. Cut geogrid at the nearest transverse bar beyond the measured length (illustrated in Figure 2) or several inches in front of the transverse bar to provide "finger shims" (Figure 8 on page 9).

LEVELING PAD CONSTRUCTION

- ▶ The leveling pad must be flat and level to assure the first course of Mesa Units will provide uniform support to the courses above it. Non-uniform support will induce tensile stresses and shear stresses in the Mesa Units above the first course that can result in cracking.
- ▶ The leveling pad (Figure 3) may be constructed with unreinforced concrete or compacted $\frac{3}{4}$ in. (1.9 cm) minus, well-graded aggregate. It is typically 12 in. (30 cm) wider than the Mesa Units, providing 6 in. (15 cm) in front of and behind the Mesa Unit allowing for wall curvature and minor alignment adjustments. It is generally 6 in. (15 cm) deep. For unreinforced concrete leveling pads, steel or wood forms are generally required to assure that the top of the leveling pad is flat and level. For aggregate leveling

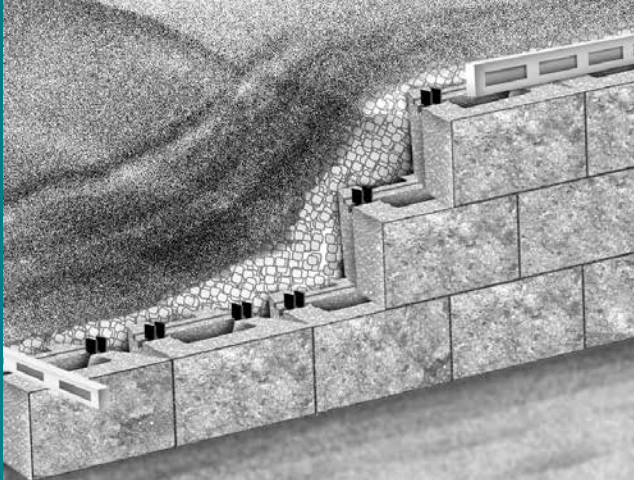

FIGURE 5: As units are placed, it is important that the units remain level from front-to-back and side-to-side. This level should be checked as each course is placed. If the units become more than 1/8 in. out of level from front-to-back, block-to-block or side-to-side, they should be brought to level by grinding and/or shimming.

pads, the aggregate is generally overfilled, compacted and then carefully trimmed down to near plan elevation. The Mesa® Units are then seated into the aggregate with a rubber mallet to the plan elevation and then leveled front-to-back and side-to-side.

- ▶ Steps in the leveling pad are required to change elevation. It is important that the height of the step is equal to the height of the number of Mesa Unit courses. In practice, the steps may be slightly more or less due to the thickness of the Tensor® Geogrid reinforcement connected between courses and to the normal dimensional tolerances of the units. Where a concrete step is not at the same elevation of the adjacent courses, shimming or grinding will be required to match the elevation and provide a flat and level bearing surface for the next course of units. As shown in Figure 4, such grinding or shimming will be required over some distance (5 ft [1.52 m] min.) from the step to assure that the top surface of the entire course of Mesa Units placed on the stepped section of the leveling pad is flat and level. Ribs or transverse bars of the Tensor Geogrid may be used as shims if their thickness is correct.
- ▶ If contract documents indicate the wall has a battered face, the contractor shall ensure that the 5/8 in. (1.6 cm) setback is accounted for at each leveling pad step. We recommend that the elevation of the leveling pad does not exceed four courses.
- ▶ The top of the Mesa Units should be adjusted as required for leveling. Shimming and/or grinding may be required. (For instructions, see the “Shimming Mesa Units” section on page 9).

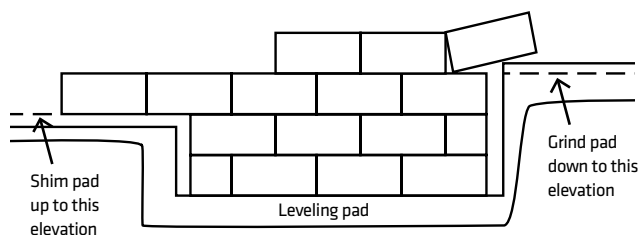

FIGURE 4

1.4 WALL CONSTRUCTION

- ▶ Wall line shall be established using a chalk or string line. Chalk line should be placed on the concrete pad along the tails of the Mesa Units. A string line can be used in lieu of a chalk line and will be necessary where the leveling pad consists of aggregate. (Alignment based on the split-faced Mesa Units may render an uneven wall face.)
- ▶ Once the leveling pad is complete (Figure 5), the first course can be installed. Place each Mesa Unit so that their sides touch and their textured face is outward. The first course must be accurately placed, carefully spaced and leveled to facilitate construction and enhance the appearance of the entire wall.
- ▶ Prior to the installation of the second course and each successive course, the tops of the units on which the course is to be placed must be swept clean. Failure to do this will result in problems with seating and leveling the Mesa Units and may also increase the likelihood of cracks developing in the units due to load concentrations as additional courses are set.
- ▶ The Mesa Units are stacked in a running bond pattern, similar to standard masonry wall construction. A limit for the shift from a perfect running bond is needed. On straight wall sections, it should be a 1/2 in. (1.28 cm) to ensure all standard connector teeth are squarely in the slots. Once placed, advance the units forward toward the face of the wall until they make contact with the connectors. The connectors do allow units to slide from side to side, so check vertical joint alignment frequently (max. 20 units) to ensure that a running bond pattern is maintained within the limits stated above.
- ▶ Drainage fill is placed to the limits shown on the drawings. Drainage and/or core fill may not be required for structural walls (see “Definitions” section under “Drainage Fill” and “Core Fill”). Proper installation of drainage materials is critical to overall wall performance. Drainage materials must be installed properly and protected during construction.



FIGURE 8: Tensar® UX Geogrid and Mesa® Connector placement on Mesa Units.

SHIMMING MESA® UNITS

- ▶ It is important that the courses of Mesa® Units are level front-to-back and side-to-side. To achieve this in the front-to-back plane, it may be necessary to grind the units or use shims between some of the courses to correct for:
 1. The thickness of the Tensar® Geogrid reinforcement ribs that cross the tails of the units or
 2. Slight differences in the height at the front and back of the units.
- ▶ For courses placed on a geogrid elevation, shims may be required on the unit's front face shell (Figure 6). The shims should be the same thickness of the geogrid rib. The material can be trimmed from the same roll of grid that is used in that particular course.

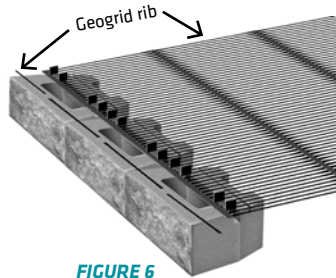

FIGURE 6

- ▶ Another alternative for shimming is to cut the geogrid so that the ribs extend approximately 1 in. (2.5 cm) onto the unit's front face shell (Figure 7).

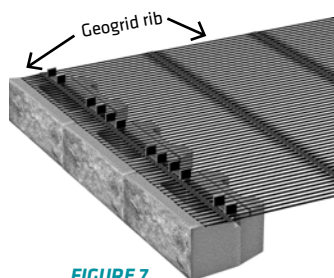
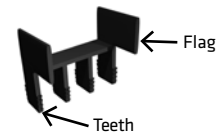

FIGURE 7

- ▶ To correct for slight differences in unit heights, a geogrid rib may be cut and placed on successive courses to bring the face and/or tail back to level. The “rib shim” and “finger shim” should be positioned on the inside of the unit's front face shell, generally within ½ in. (1.27 cm) of the unit's core (see shimming Figures 6 and 7). This will place less stress on the underlying block than would exist if the shim was placed near the unit's front face.
- ▶ Tensar Geogrids may be draped over the upper courses of the wall until the reinforced fill reaches the level of the geogrids. To ensure that the Mesa Wall's geometry is being maintained, a string line should be pulled after each course is set. The string can be referenced from the connector slot or tail of the Mesa Unit.

NOTE: To ensure proper installation, the geogrid transverse bar must be pulled to contact with the teeth of the Mesa Connector.



1.5 GEOGRID AND CONNECTOR PLACEMENT

The following section covers the installation for both Tensar Geogrids and Mesa Connectors (Figure 8) based on the use of both the Mesa Standard and Mesa XL Units only.

- ▶ At the end of each day, the Contractor must ensure the reinforced backfill is graded to drain water away from the face of the wall. Berms and/or ditches must also be in place and functioning to prevent the entrance of runoff into the wall construction site.

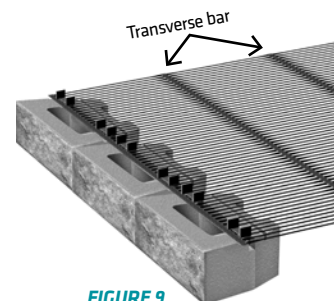

FIGURE 9

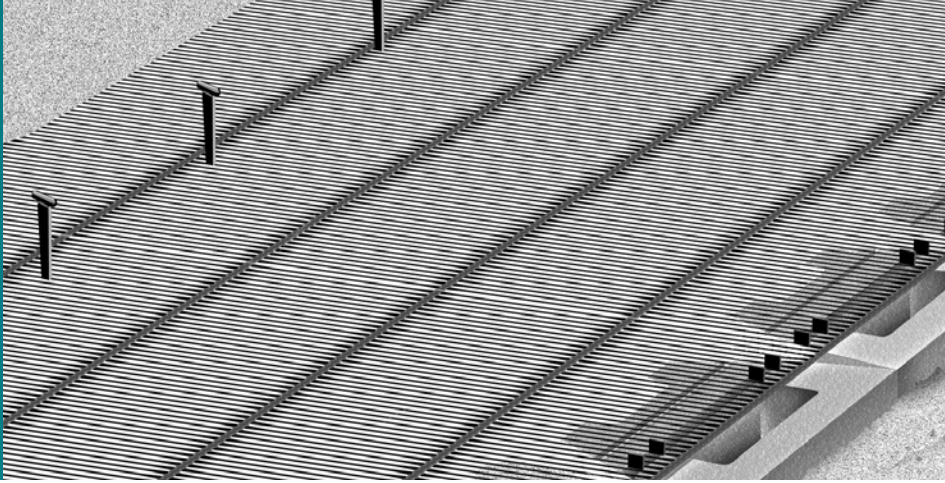

FIGURE 10: Pinning
Tensor® Geogrids.

- ▶ At the location and elevation shown on the plans, install the appropriate Tensor® UX Geogrid (type and length specified) ensuring the transverse bar of the grid is in the right location (Figure 9 on page 9). A connector should be placed in each connector slot of the Mesa Units. On courses with geogrid, all four connector's teeth must penetrate through the grid apertures and into both connector slots. To align the connectors over the slots, the transverse bar may be cut midway between the connectors. The transverse bar should be snug against the connector teeth before final seating of the connector.
- ▶ Connector flags must be oriented in the proper direction for a "battered" or "near-vertical" wall as per the contract documents. Connector placement with flags forward (toward the wall face) will render a near-vertical wall. Connector placement with the flags pointed away from the wall face will provide an automatic $\frac{5}{8}$ in. (1.6 cm) setback.
- ▶ The reinforced fill must meet specification, be compacted to the required density and be graded reasonably smooth. On courses that require geogrid, the reinforced fill must be at the top of the course's same elevation for a distance of 3 ft (.91 m) before the fill can be gradually sloped.
- ▶ Remove slack from geogrid by pulling it taut and then anchoring it with stakes and/or rods (Figure 10). The stakes used to position the geogrid tail can be withdrawn once the fill is in place and then reused on subsequent lifts. A pitchfork can also help remove slack by inserting it at the tail of the geogrid and pulling until the fill has been placed on the grid. Removal of any geogrid slack will help prevent wall face movement caused by translation of the slack toward the wall face.
- ▶ Fill placement shall be performed to minimize geogrid slack development. Fill should meet specification and be spread away from or parallel to the wall face. By doing this, any slack that may develop will be pushed toward the free (unconnected) end of the geogrid. Unless the contract documents are stringent, the loose lifts of the reinforced fill must not exceed 6 in. (15 cm) where hand compaction equipment is used or 10 in. (25 cm) where heavy compaction equipment is used. Thicknesses may vary depending on the approved project's specific soil types. The fill shall be compacted to 95% of ASTM D-698 or as required by the contract documents. Only hand-operated compaction equipment shall be used within 3 ft (.91 m) of the tails of the units.
- ▶ Heavy equipment should not be used within 3 ft (.91 m) of the back of the facing units, and tracked construction equipment should not be operated directly on Tensor Geogrids. Rubber tired equipment may be operated on the geogrid providing the subgrade is not pumping or rutting. Turning of tired equipment should be minimized to prevent dislocation or damage to the geogrid or facing units. Equipment must travel slowly and with sufficient care to avoid dislocating the geogrid or facing units.
- ▶ Install the Cap Units, if required, by attaching them to the Mesa Units below using an approved exterior concrete adhesive. Cap Units may be placed with a nominal 1 in. (2.54 cm) overhang or flush with the wall face.
- ▶ Wall penetrations may be accommodated by cutting the Mesa Units to fit with a utility saw and a mason's hammer. The small voids, less than 1 in., (2.54 cm) can then be closed with a cement and sand mix or other methods that have been approved by the engineer.



Mesa® Curves and Corners

2.1 CONCAVE CURVES

When possible begin a Mesa® Wall with a concave curve from the center of the curve, alternating left and right of the center unit. When building with a $\frac{5}{8}$ in. (1.6 cm) setback, each Mesa Unit falls behind on a concave curve relative to any units below.

NOTE: Refer to the “Construction and Quality Control” section of this manual for proper installation procedures of connectors, units and geogrids for all courses.

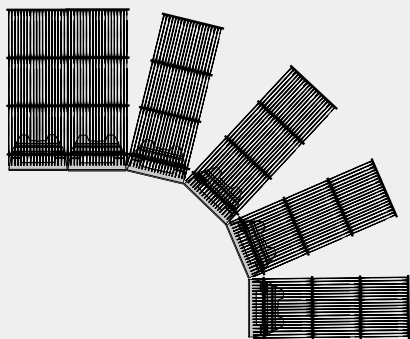
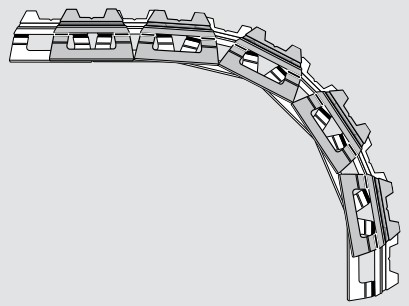
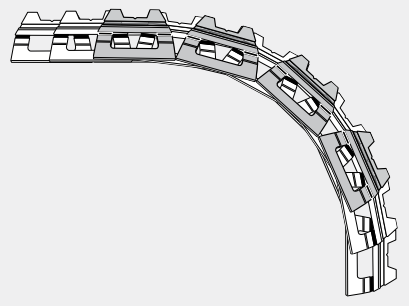
1st Course	2nd Course	3rd Course
 <p>Follow standard installation instructions for preparing the subgrade and leveling pad. When placing the first course,* it is suggested that a flex pipe be placed on the unit's tail to ensure a smooth curve. If using a $\frac{5}{8}$ in. (1.6 cm) setback, overlap corners of units on the base course. The overlap amount will vary based on the curve size. The radius becomes larger as the wall becomes taller, therefore gapping will occur (max. gap size $\frac{1}{2}$ in. [1.27 cm]). If the maximum gap is exceeded, one flag may be removed from each connector to close the gap.</p>	 <p>Follow standard installation instructions for backfilling and course placement. On the second course, set the first unit on halfbond to the base course in the center of the concave curve where possible. Work in both directions to minimize movement off bond.</p>	 <p>Follow standard installation procedures for backfilling and course placement. On the third course, set the first unit on halfbond to the second course in the center. Work in both directions to minimize movement off bond. Ensure that all four teeth of the connector are positioned in the connector slot. At the ends of the curve, the running bond must be re-established to develop full connection capacity. This may require cutting or grinding of the facing units.</p>

*NOTE: Course 1 - On tight curves, grid may be cut lengthwise to the width of the Mesa Units to ensure the transverse bar engages both connectors.



2.2 CONVEX CURVES

As with concave walls, begin a wall with a convex curve from the center of the curve, alternating left and right of the center unit. When building with a $\frac{5}{8}$ in. (1.6 cm) setback, each unit reduces in radius on a convex curve relative to the unit below. Conversely to concave, a convex curve's radius gets smaller with each additional course.

NOTE: Refer to the "Construction and Quality Control" section of this manual for proper installation procedures of connectors, units and geogrids for all courses. Minimum recommended radius at top of wall is 55 in. (140 cm) for convex curves.

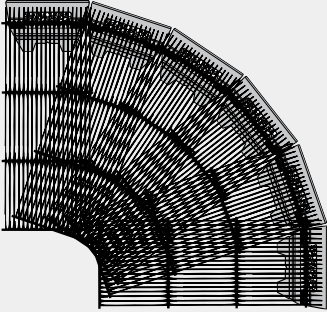
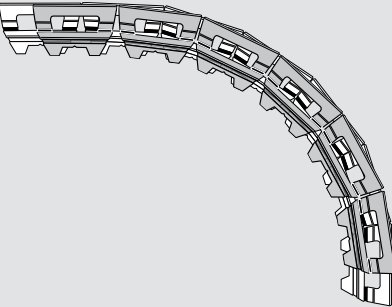
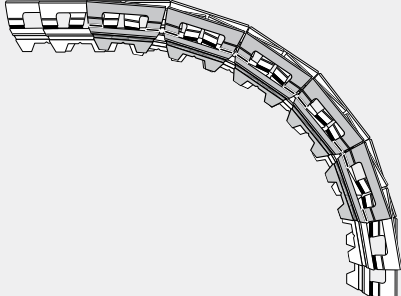
1st Course	2nd Course	3rd Course
 <p>Follow standard installation instructions for preparing the subgrade and leveling pad. When placing the first course,* it is suggested that a flex pipe be placed on unit's tail to ensure a smooth curve. If using a $\frac{5}{8}$ in. (1.6 cm) setback, gap the units on the base course no more than $\frac{1}{2}$ in. (1.27 cm). The radius becomes smaller as the wall becomes taller, therefore binding will occur. If binding on any course begins to occur, trim the sides of the units with a concrete saw to realign.</p>	 <p>Follow standard installation instructions for backfilling and course placement. On the second course, set the first unit on halfbond to the base course in the center of the convex curve where possible. Work in both directions to minimize movement off bond.</p>	 <p>Follow standard installation procedures for backfilling and course placement for the third course. On the third course, set the first unit on halfbond to the second course in the center. Work in both directions to minimize movement off bond. Ensure that all four teeth of the connector are positioned in the connector slot. At the ends of the curve, the running bond must be re-established to develop full connection capacity. This may require cutting or grinding of the facing units.</p>

***NOTE:** Course 1 - On tight curves, grid may be cut lengthwise to the width of the Mesa® Units to ensure the transverse bar engages both connectors. Provide 3 in. (7.6 cm) (min.) soil cover between overlapping layers of Tensar® Geogrid reinforcement.



2.3 90-DEGREE OUTSIDE CORNERS

Corner Units simplify installation and provide a sharply defined and visually appealing component to any Mesa® Wall. Installation is simple, quick and requires no special equipment or specialized personnel.

NOTE: Refer to the "Construction and Quality Control" section of this manual for proper installation procedures of connectors, units and geogrids for all courses.

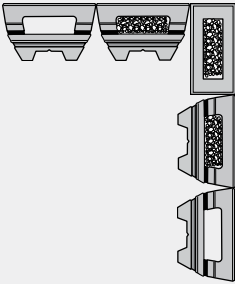
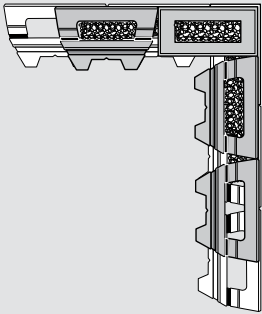
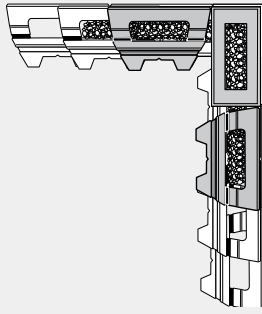
1st Course	2nd Course	3rd Course
 <p>Follow standard installation instructions for preparing the subgrade and leveling pad. Working with the Corner Unit, place units tightly against each other on the first course. Granular fill must be placed in the Mesa Corner Unit as well as in each Mesa Unit to either side of the Corner Unit.</p>	 <p>Follow standard installation instructions for backfilling and course placement. When building a Mesa Wall with a $\frac{5}{8}$ in. (1.6 cm) setback, the shorter 9 in. (23 cm) side of the Corner Unit should be field cut to account for the setback and to maintain a running bond. On the second course, alternate the direction of the Corner Unit and set units on halfbond to the base units. Secure the Corner Unit to the unit below using an approved concrete exterior adhesive. Granular fill shall be placed in the corner unit as well as in each Mesa Unit to either side of the Corner Unit.</p>	 <p>Follow standard installation procedures for backfilling and course placement. When building a Mesa Wall with a $\frac{5}{8}$ in. (1.6 cm) setback, the shorter 9 in. (23 cm) side of the Corner Unit should be field cut to account for the setback and to maintain a running bond. On the third course, alternate the direction of the Corner Unit and set units on halfbond to the second course. Secure the Corner Unit to the unit below using an approved concrete exterior adhesive. Granular fill must be placed in the corner unit as well as in each Mesa Unit to either side of the Corner Unit.</p>



2.4 90-DEGREE INSIDE CORNERS

90-degree inside corners require some preparation and planning for results that are sharply defined. Once the initial sizing is determined, installation is quick and simple. For the most visually appealing walls, the field cuts illustrated below should be applied to the shorter (Wall A) of the two walls.

NOTE: Refer to the "Construction and Quality Control" section of this manual for proper installation procedures of connectors, units and geogrids for all courses.

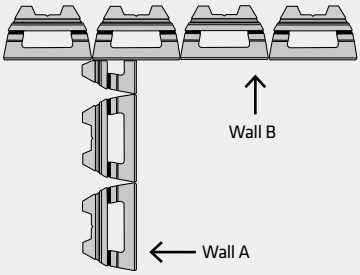
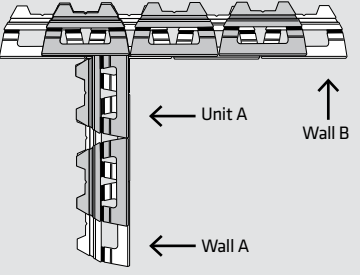
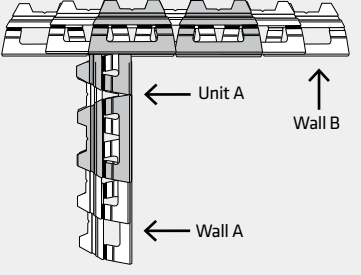
1st Course	2nd Course	3rd Course
 <p data-bbox="186 1381 576 1596">Follow standard installation instructions for preparing the subgrade and leveling pad. First course construction can begin at the corner or at a point beyond the corner. At the inside corner, begin with a Mesa® Unit cut to approximately 1/3 of the original face length. From the Corner Unit, position the Mesa Units tightly against each other.</p>	 <p data-bbox="617 1381 990 1621">Follow standard installation procedures for backfilling and course placement. Refer to the above illustration for proper unit placement on the second course. When building this course, begin with Wall B, and construct Wall B past the extent of Wall A. Measure and field cut Unit A to provide a symmetric running bond over the first course.</p>	 <p data-bbox="1047 1381 1437 1621">Follow standard installation procedures for backfilling and course placement. Refer to the above illustration for proper unit placement on the third course. When building this course, begin with Wall B, and construct Wall B past the extent of Wall A. Measure and field cut Unit A, such that the third course units are centered over the units in the first course.</p>



Mesa® Steps and Stairs

3.1 STEPS IN FRONT OF WALL

When installing steps, simply combine Mesa® Standard, Corner and Cap Units to realize virtually any wall design.

Follow the installation techniques previously stated in this manual. Different riser heights can be achieved by varying the

location of the base Standard Unit (see detail on page 16). Mesa Standard Units used for step construction should be filled with granular fill or concrete.

NOTE: Refer to the "Construction and Quality Control" section of this manual for proper installation procedures of connectors, units and geogrids for all courses.

1st Course

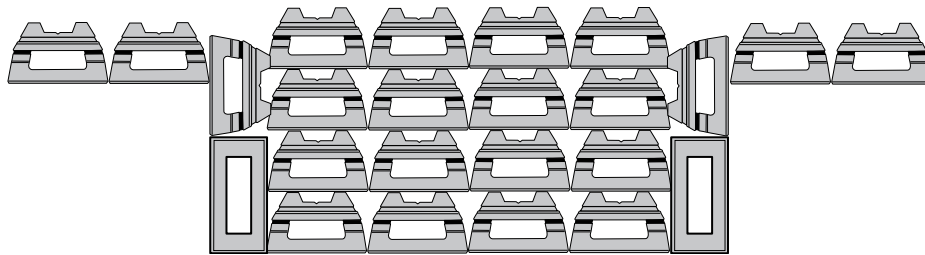

2nd Course

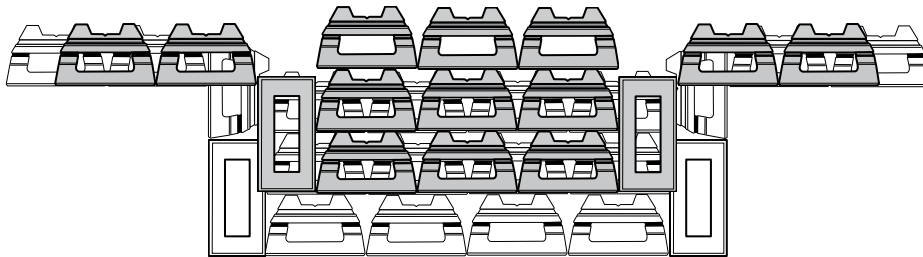

NOTE: Various tread material can be used to cap steps and stairs including, but not limited to: Mesa Cap Units, pavers, natural stone and concrete. When required by the engineer, an approved exterior concrete adhesive should be used. Please consult your local Mesa Representative for more information.



3.2 STEPS IN WALL

Riser Height Detail

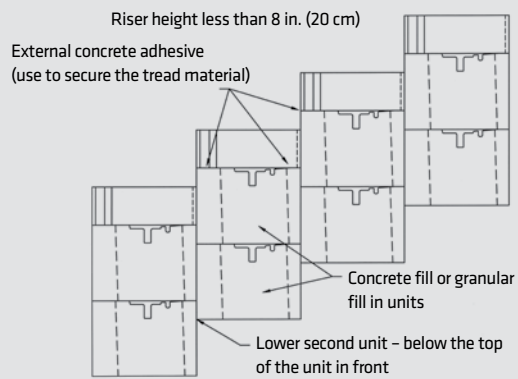

NOTE: Refer to the "Construction and Quality Control" section of this manual for proper installation procedures of connectors, units and geogrids for all courses.

1st Course

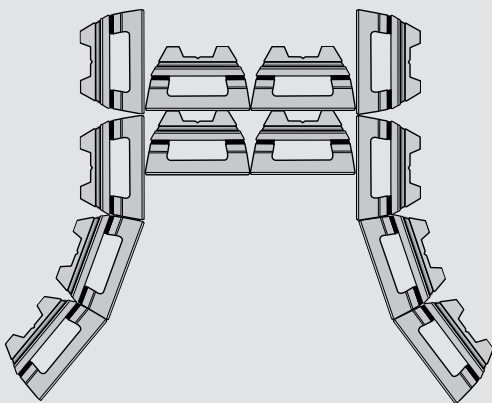

2nd Course

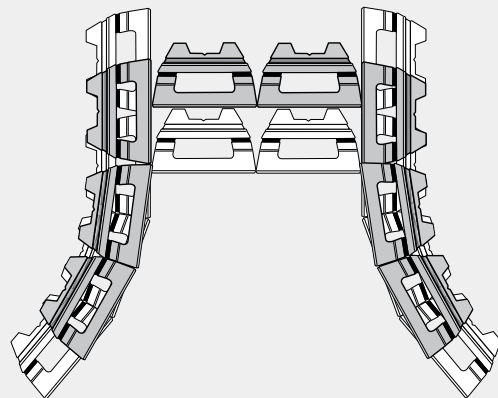



Tiered and Top of Wall Finishes

4.1 TIERED WALLS

Tiered Mesa® Walls offer a visually pleasing and less obtrusive alternative to conventional wall construction. On sites that provide sufficient land area for this application, these walls are typically designed with greenspace between the tiers. For tiered walls to be designed separately, the distance between the lower Wall A (at its top) and the upper Wall B (at its base) must be at least twice the height of the lower Wall A (Figure 11). If this condition does not exist, the lower Wall A must be designed to account for the additional loading of the upper Wall B.

NOTE: Refer to the “Construction and Quality Control” section of this manual for proper installation procedures of connectors, units and geogrids for all courses.

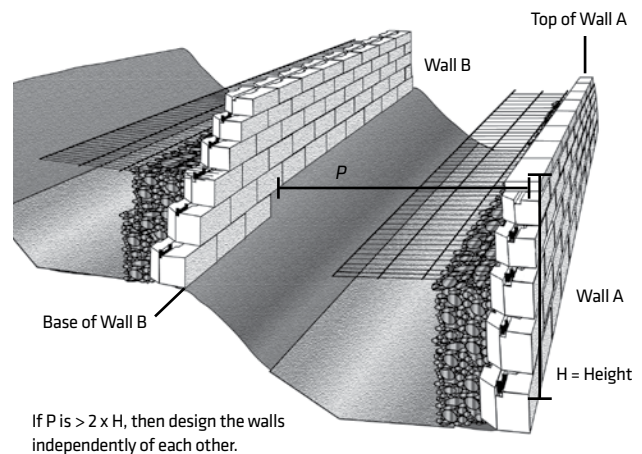

FIGURE 11

4.2 TRAFFIC BARRIERS

Mesa Retaining Walls can be easily capped with reinforced concrete traffic barriers. Following the wall installation, set and secure forming materials along the top course of the Mesa Wall according to standard procedures. When the design calls for an overhanging barrier, form the front edge by attaching an “L” shape forming material to the face of the Mesa Wall. Construct the barrier as designed, including, but not limited to, the use of the control joints (Figure 12).

NOTE: Refer to the “Construction and Quality Control” section of this manual for proper installation procedures of connectors, units and geogrids for all courses.

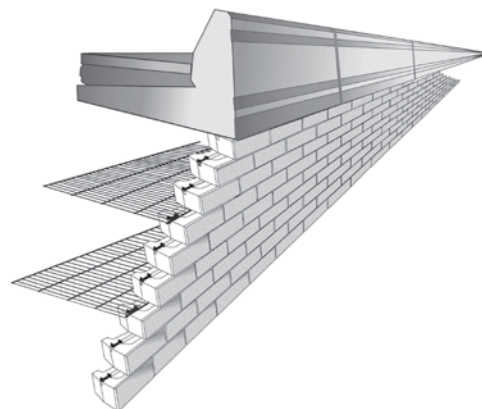

FIGURE 12



4.3 GUIDE RAILS

Guide rails can be easily placed along the top of a Mesa Wall according to the standard installation procedures. Guide rail posts may be placed by cutting holes in the Tensar Geogrid reinforcement, or the post may be driven through the geogrid. The guide rail post location, design and impact on the Mesa Retaining Wall shall be taken into account by the design engineer. Guide rails can also be placed into sonotubes positioned during wall construction and then filled with concrete. Tensar Geogrids can be cut to accommodate the sonotubes.

4.4 HANDRAILS AND FENCE POSTS

Similar to guide rail installation, handrails and fence posts can be placed behind the Mesa Units as described in section 4.3. Placement and spacing of the handrail or fence will be determined by the project specific loading and geometry of the structure. The typical detail provided on page 21 addresses handrail installation for a 50 pound (23 kg) per lineal foot horizontal force applied at 42 in. (107 cm) above the finished grade behind the Mesa Units. For loading conditions other than this, the wall designer should perform additional calculations to confirm the stability of the affected portion of the wall. For additional information please contact Tensar Engineering at **800-TENSAR-1**.

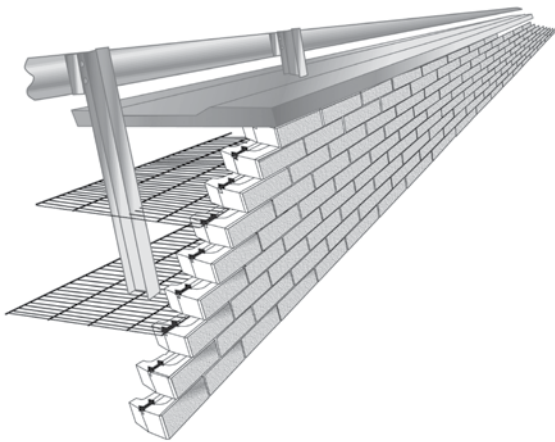

FIGURE 13

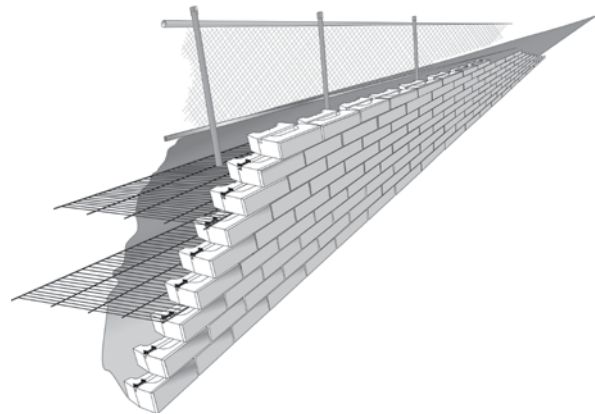

FIGURE 14



Mesa® Wall Details

The following section contains the standard details for designing generic Mesa Walls with special considerations. Please refer to the "Construction and Quality Control" section of this manual for proper installation procedures of connectors, units and geogrid. Specific details for specific walls are the responsibility of the owner and the engineer.

Typical Leveling Pad Step Detail

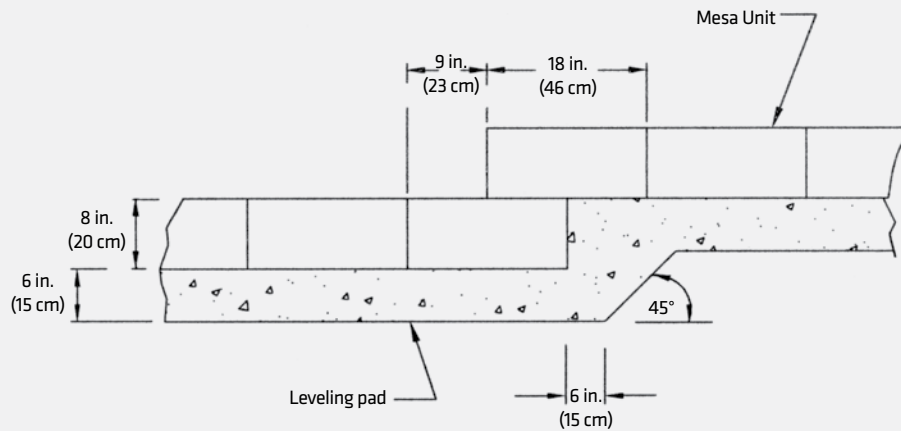

Typical Leveling Pad Detail

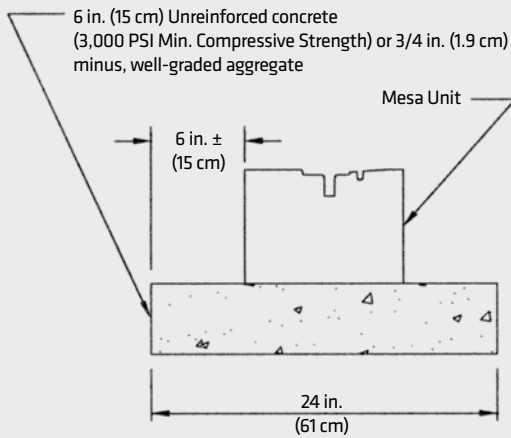

Typical 90-Degree Curve Detail

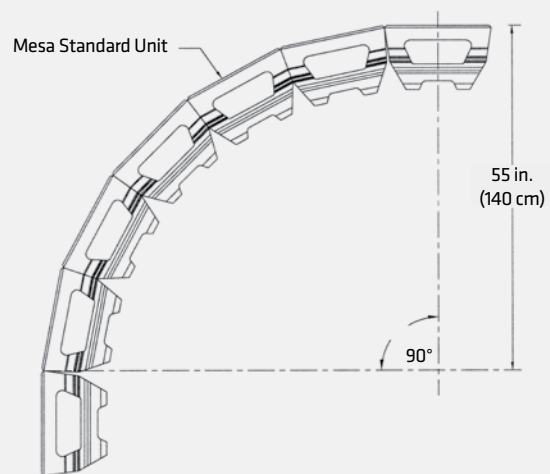



Typical Tiered Detail – 2 Tiers

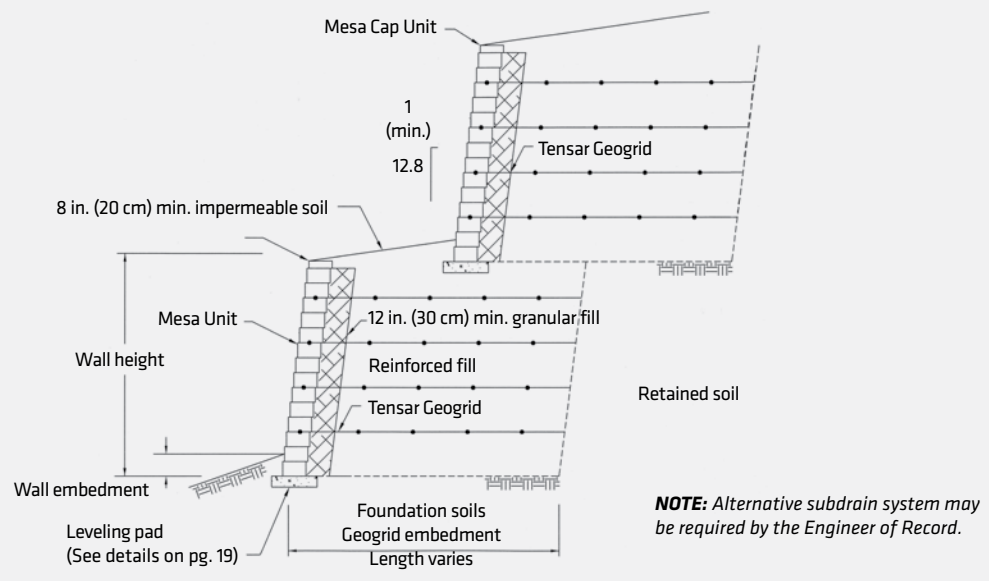

Typical Tiered Detail – 3 Tiers

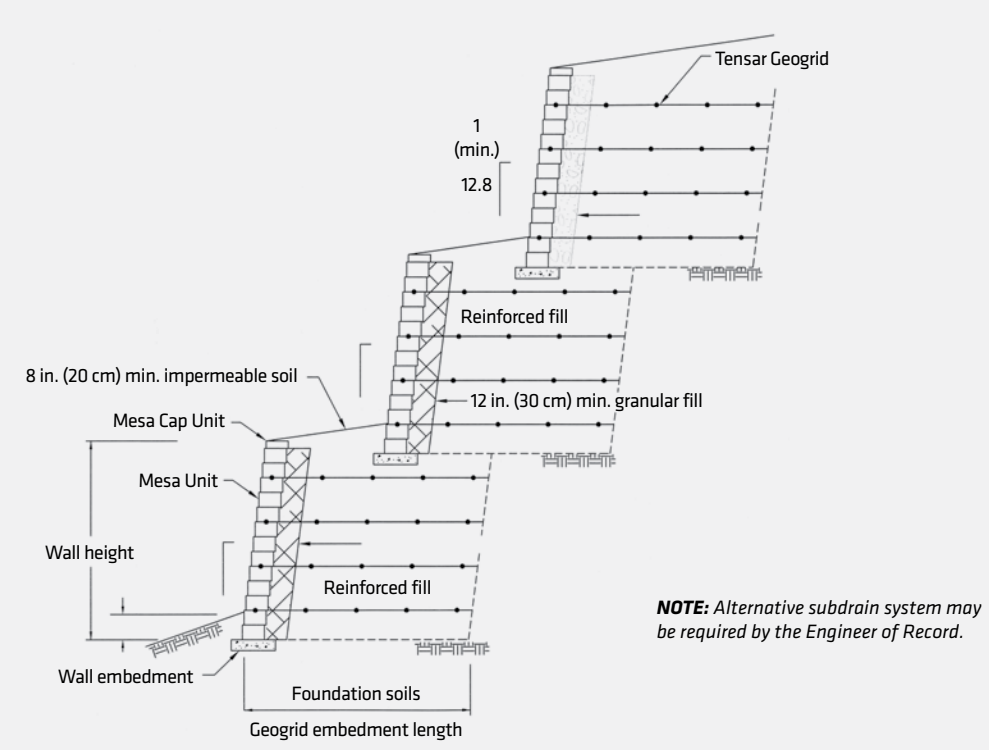



Handrail on Top of Wall

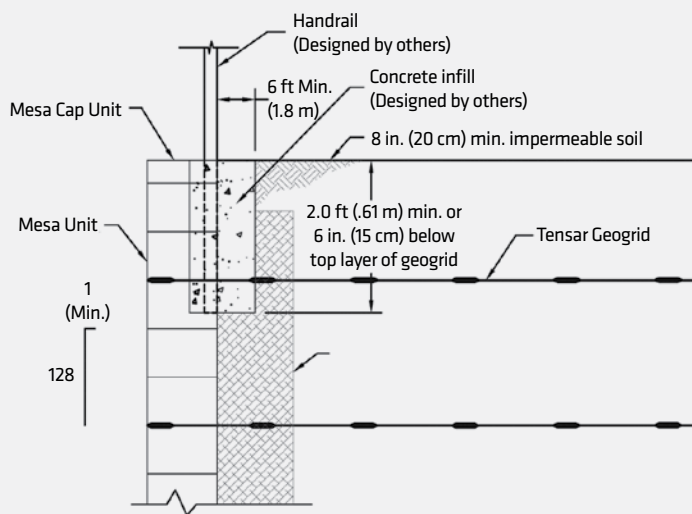

Step 1: Place granular fill to bottom of handrail.

Step 2: Place top layer of Tensar® Geogrid and remaining Mesa® Units above it.

Step 3: Cut Tensar Geogrid and then set rail post. Form and pour concrete infill at tail of the Mesa Units.

Plan View - Detail on Handrail on Top of Wall

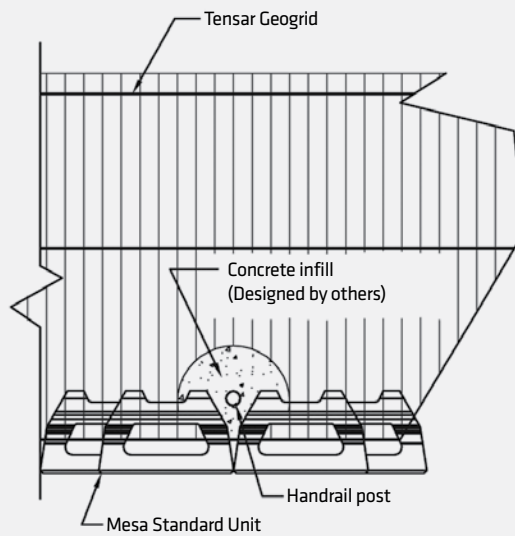



Typical Detail with Chain Link Fence

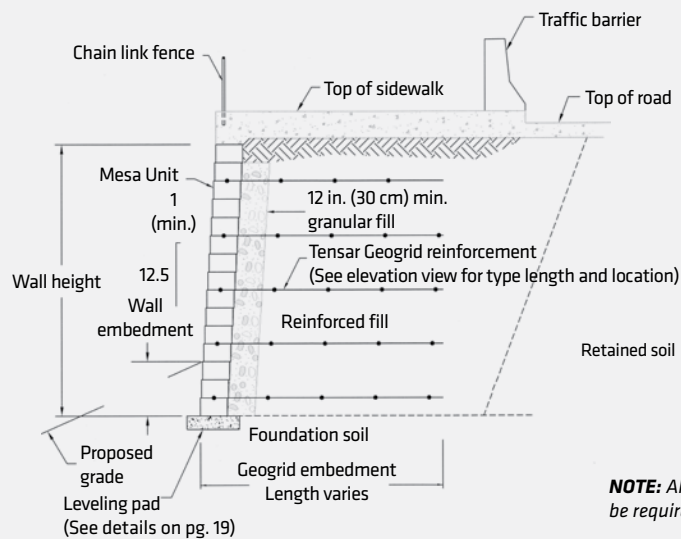

Typical Detail of Traffic Barrier Behind Wall

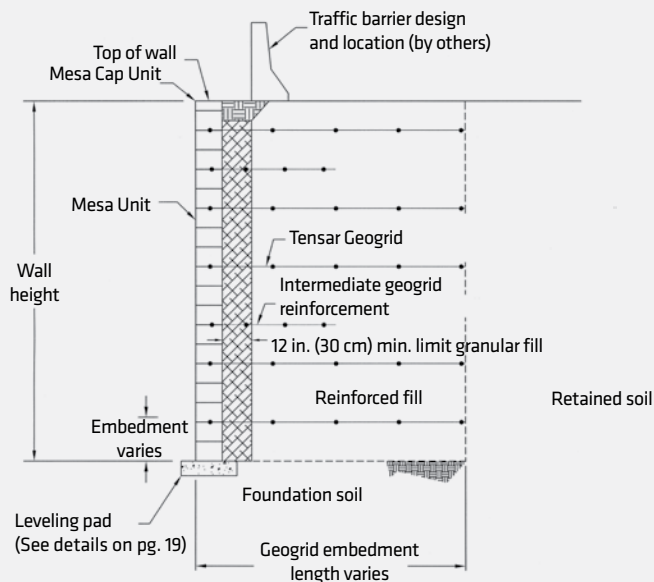



Typical Detail of Traffic Barrier on Top of Wall

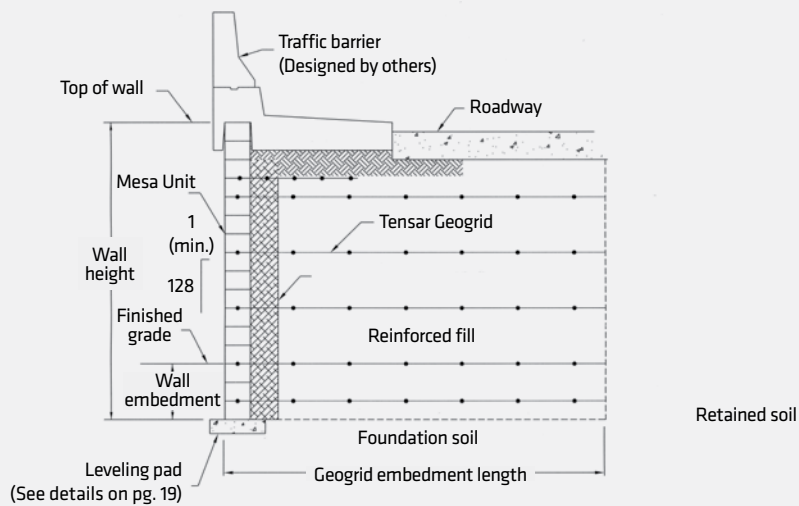

Typical Detail with Utility Corridor Behind Wall

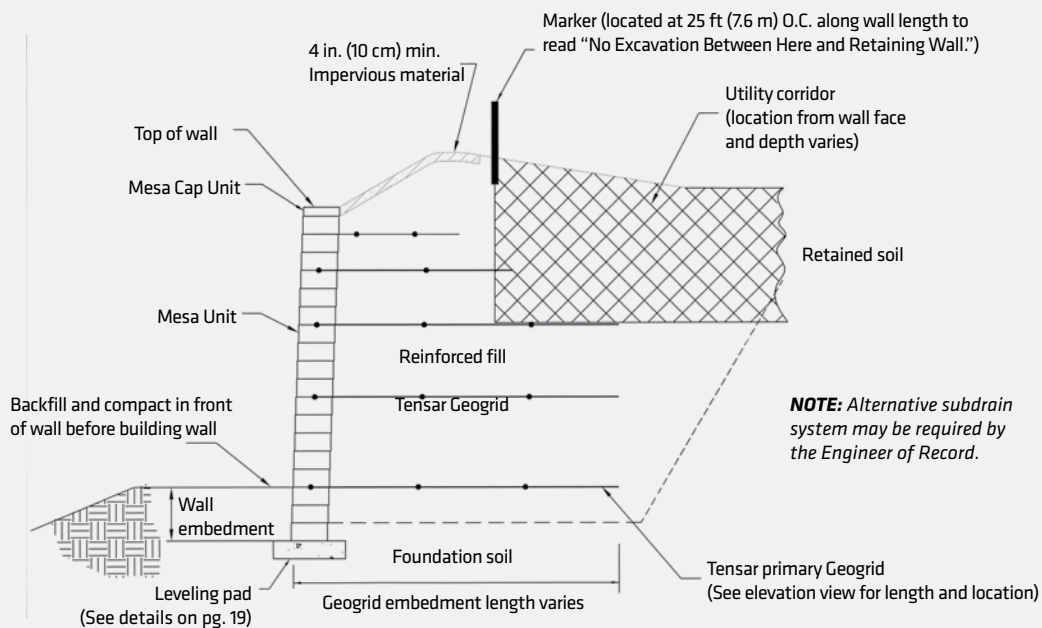



General Terms

Approved Construction Drawings

The final wall drawings provided by Tensor to the Contractor for submittal to the Owner/Owner's Engineer and subsequently approved by the Owner/Owner's Engineer for construction.

Contract Documents

The Agreement between the Owner and the Contractor, including conditions of the contract drawings, specifications and the provisions of the Agreement between the Contractor and the supplier of the Mesa® Systems. These documents should also include addenda and other modifications issued prior to the execution of the Contract.

Contractor

The individual, firm or corporation acting directly through its agents or employees to undertake the execution of the work under terms of the contract.

Core Fill

Free-draining, coarse-grained soil that is placed within the empty cores of the segmental concrete facing units. Core fill may not be required within the Mesa Unit if the Contractor can provide the Engineer and/or Architect with connection testing performed without core fill verifying that the connection strength of the system exceeds the requirements set forth in the design data.

Engineer

The Owner's representative with authoritative charge over the inspection and acceptance of the wall construction in accordance with the contract documents.

Granular Fill

Free-draining, coarse-grained soil which is placed behind the Mesa Segmental Concrete Facing Units and in the openings between the Mesa Units as specified on the plans. The Engineer and/or Architect may specify a nonwoven geotextile which meets AASHTO M288-96 subsurface drainage requirements in lieu of drainage fill.

Inspector

The owner's authorized representative assigned to see that the workmanship and materials are in accordance with the terms of the contract.

Mesa Connector

A proprietary mechanical connection device made of high density polymer with fiberglass inclusions to positively connect the Tensor® Geogrid to the Mesa Units.

Owner

The Owner of the project with whom a contract has been made for payment for the work performed under the terms of the contract.

Plans

The part of the contract documents consisting of the approved plans, profiles, typical cross sections, working drawings and supplemental drawings, or exact reproduction thereof, which shows the location, character, dimensions and details of the work to be performed.

Reinforced Fill

The specified soil material that interacts with the geogrid reinforcement to create a flexible gravity mass. Its limits extend from the back of the facing element or granular medium to the tails of the soil reinforcement or as indicated in the plans.

Setback (Batter)

The rearward offset from the vertical plane between two adjacent block courses created by the orientation of the flags on the Mesa Connectors.

Specifications

A description of the quality and quantity of the materials and workmanship that will be required of the Contractor in the execution of the work under the contract between the owner and the Contractor.

Tensor Geogrids

A proprietary polymeric grid formed by a regular network of integrally connected tensile elements with apertures of sufficient size to allow interlocking with surrounding soil, rock or earth and connection to Mesa Facing Units that function as tensile reinforcement.

Notes

Notes

Tensar®

Tensar International Corporation
2500 Northwinds Parkway, Suite 500
Alpharetta, Georgia 30009

tensarcorp.com
800-TENSAR-1

Distributed by: